



CHINA INTERNATIONAL MARINE CONTAINERS (GROUP) LTD

2017















**The overall trend
of the industry
is positive.**



05 26	6 4. 6 3-. .	4 - . 0 021
23 63	235 - . 3	03. 560
06 6-	5. 135	25 0.





A set of four horizontal blue lines for writing, with a blue curly bracket on the left side spanning the first two lines.





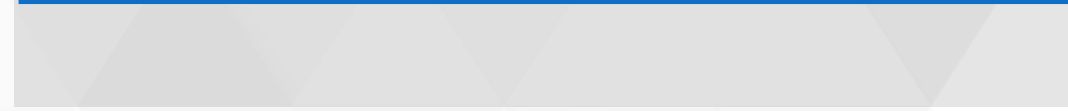

34 . . .1 2-6 0 4-0 356

22- 1 . 0 655

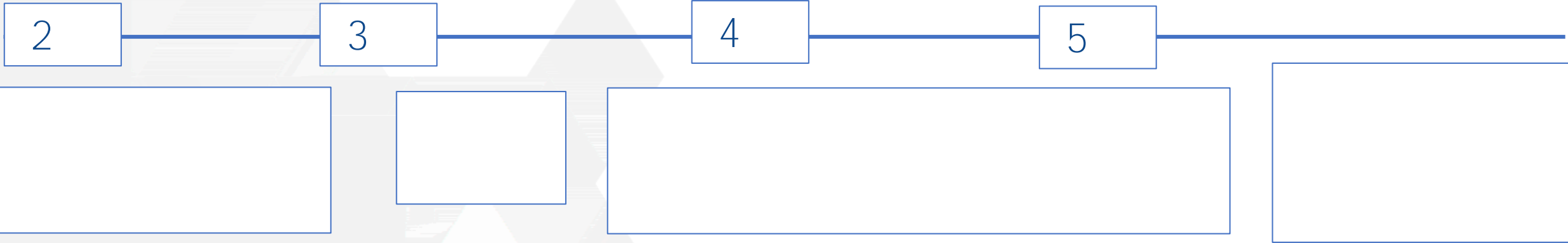
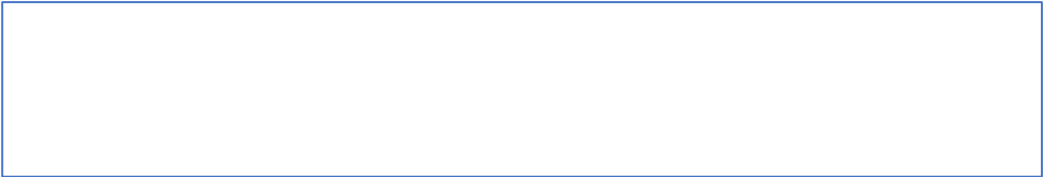



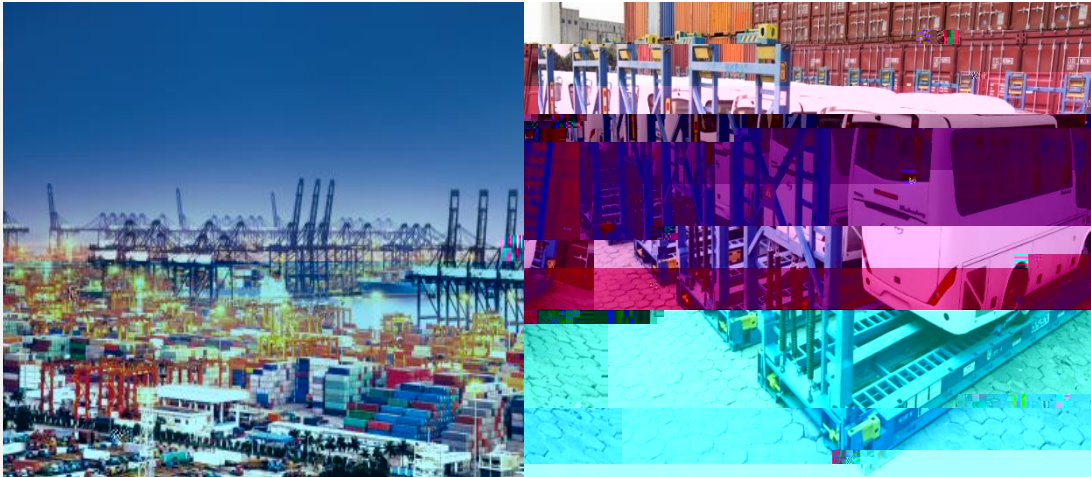

. 3 22

0 42. -

0 . 5 3. 4

. 3 .

24 01-

35 101

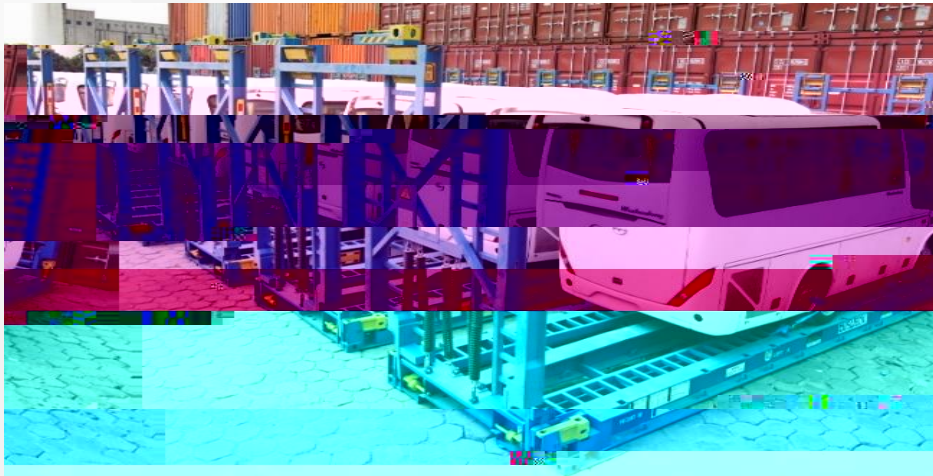
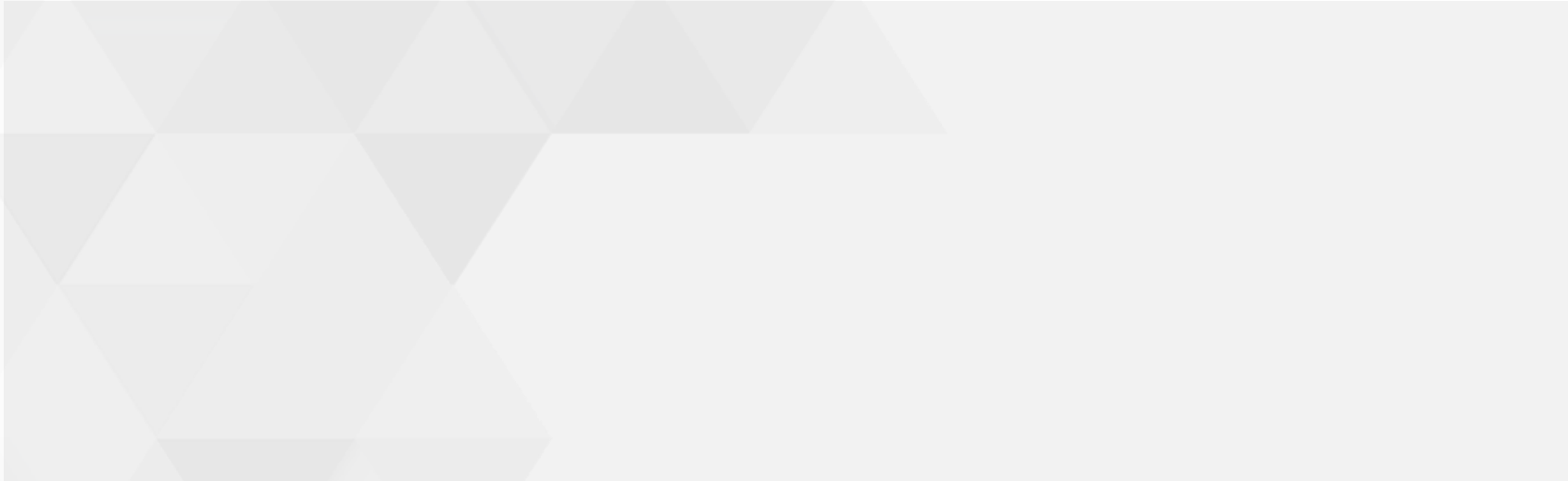

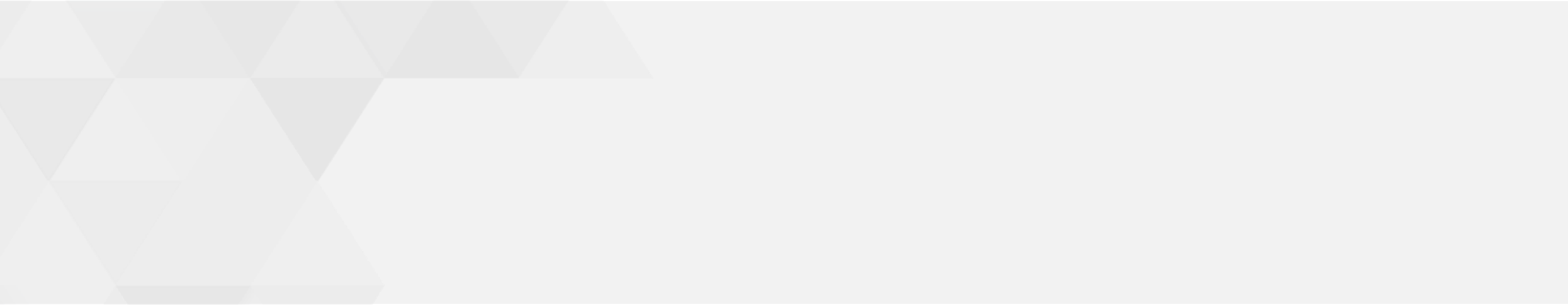
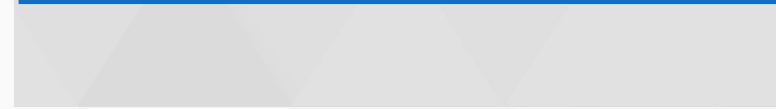



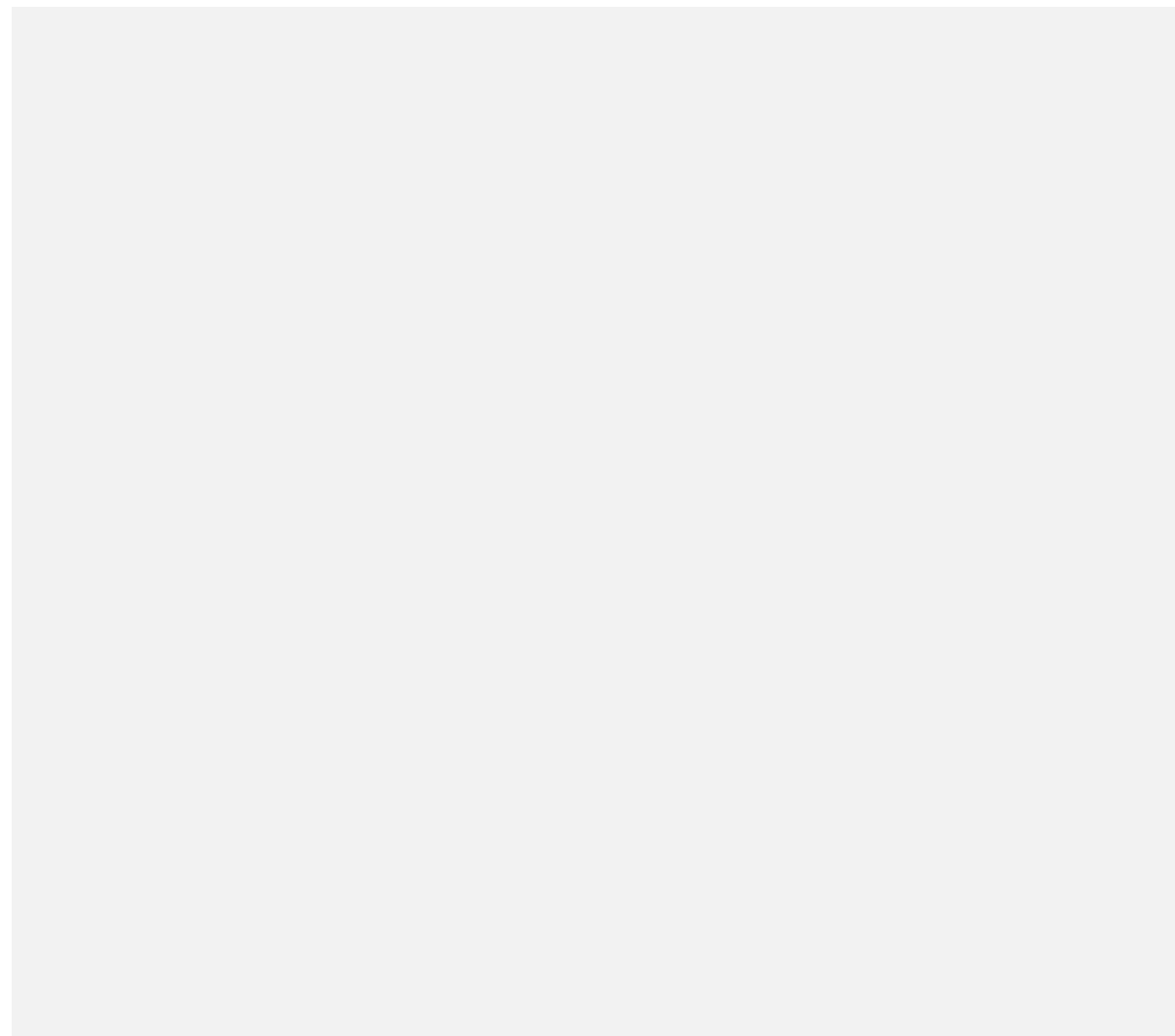

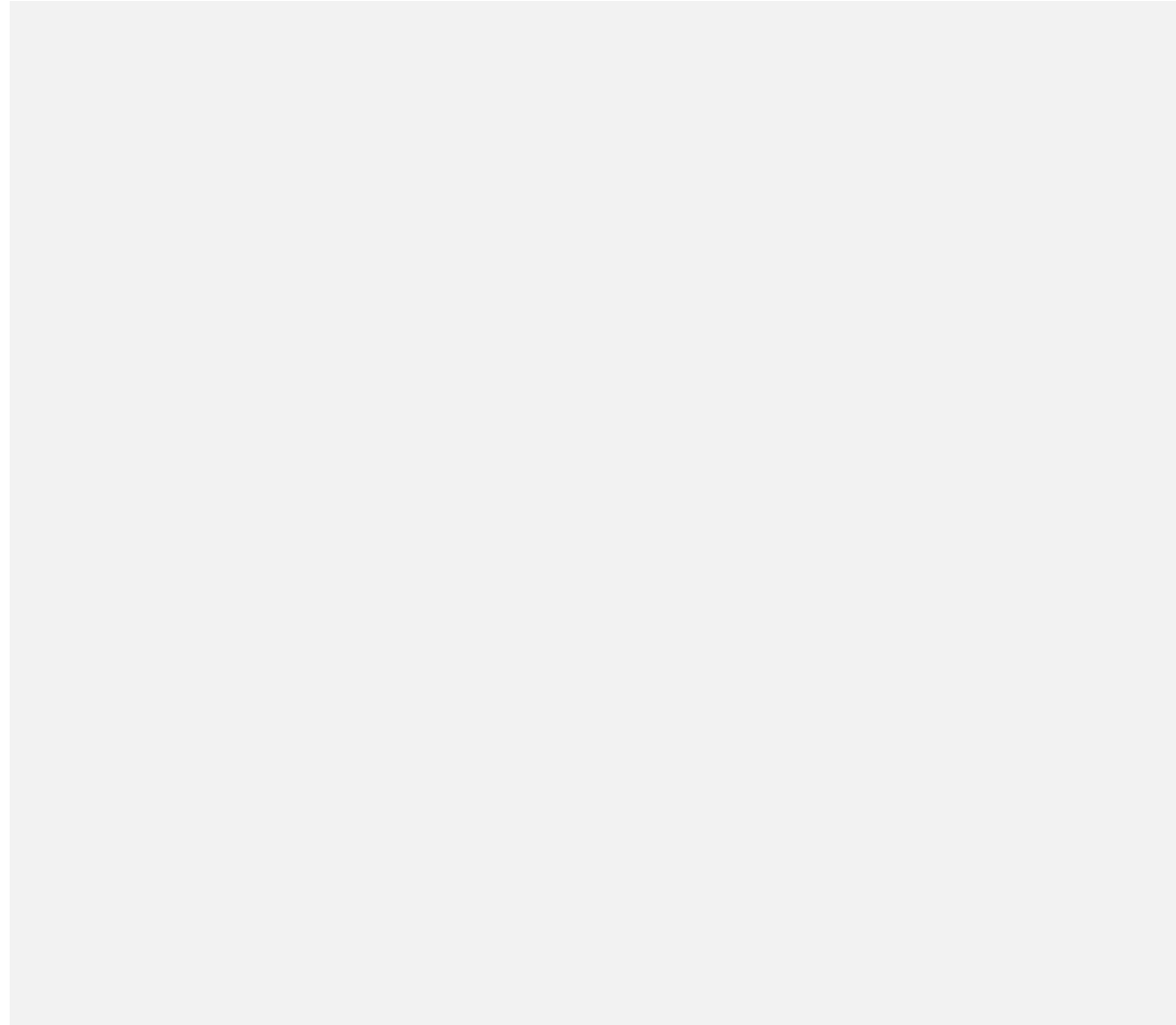
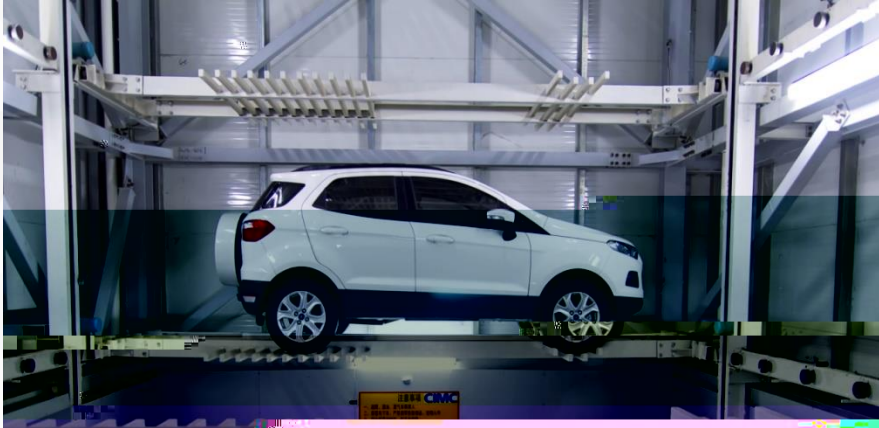



2 4.

64 331

0. 2 365

2 -1

32 - 02

1 442

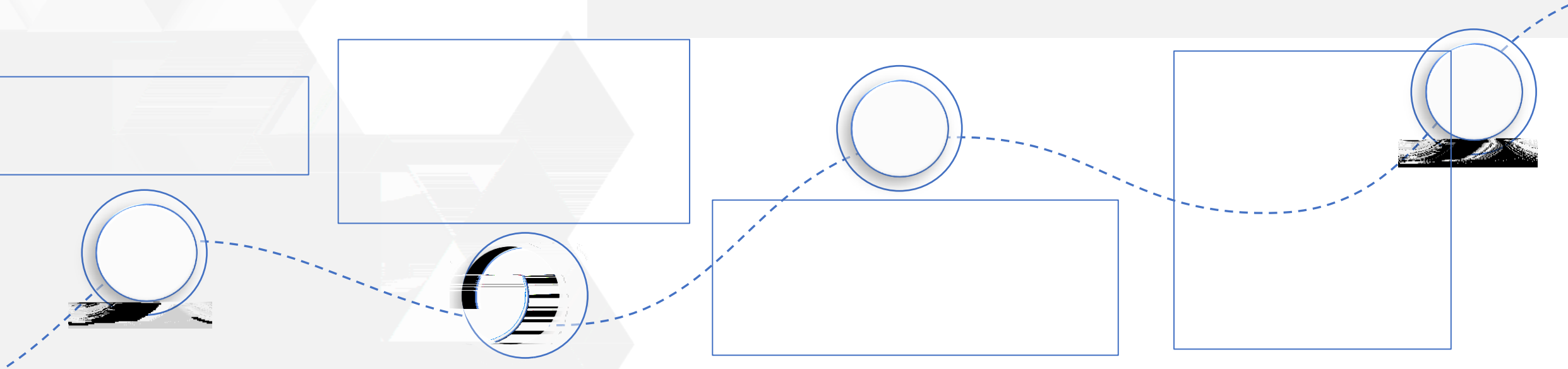
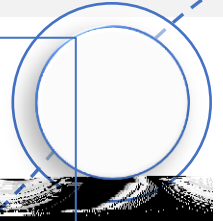
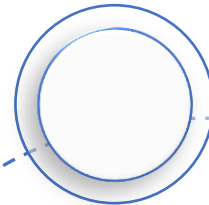
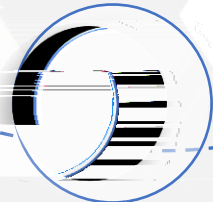
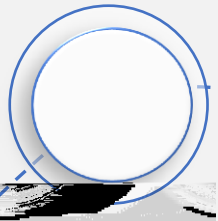
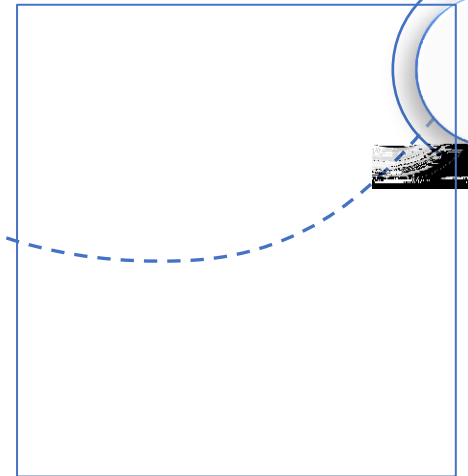
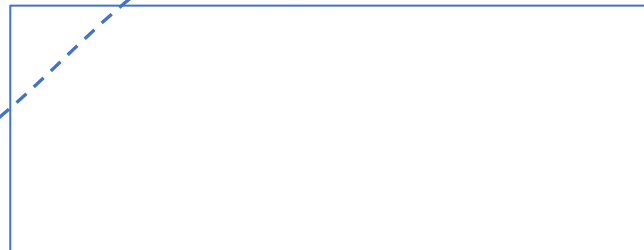
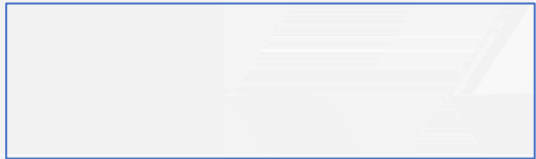

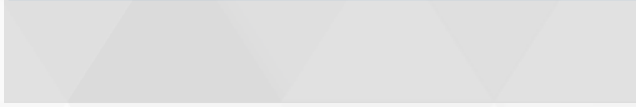

0 -	. .15 -1-	. . .1 023
. 0 42	2. 3 -64	120 4-5





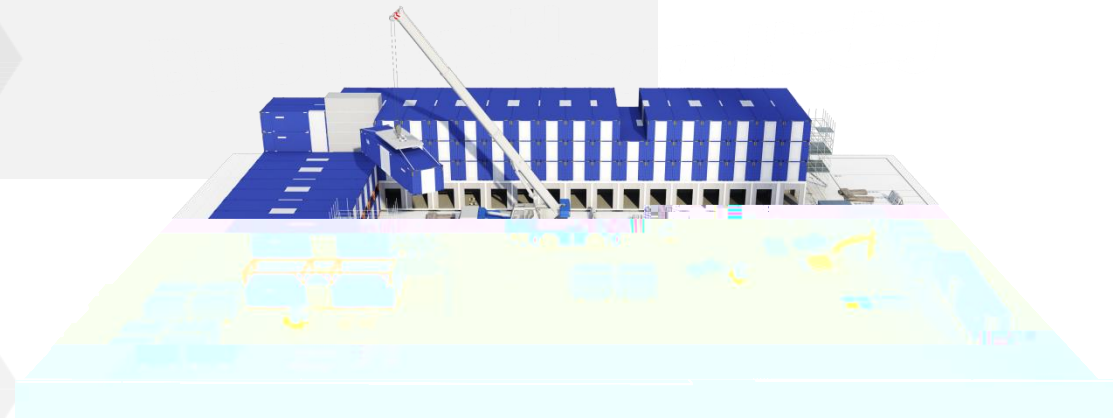





M III





Gross profit margin of principle business (unaudited)

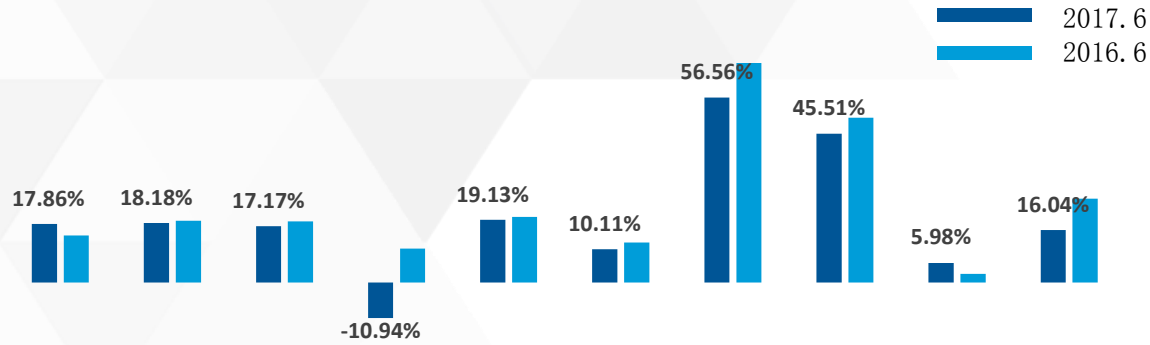

Gross profits of principle business (unaudited)

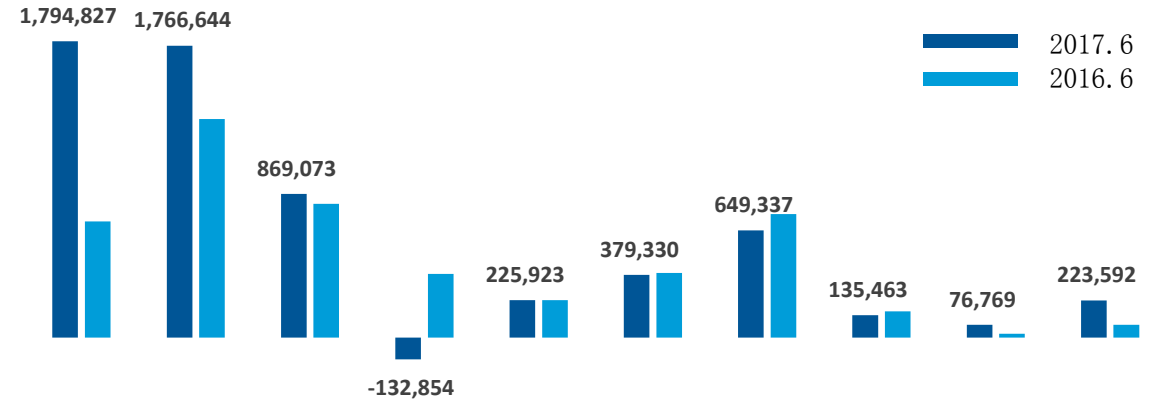

Net profits of principle business (unaudited)

